

Deep UV LED Package (SCM35BUC00E1Z1)

Product Introduction

The SCM35BUC UVC emitter is specially designed for applications requiring high radiant power in a SMD package for optimum life and device performance.

Features & benefits

- I With Sanan's DUV FC series dies
- I Customizable emission wavelength
- I Industry standard 3.5mm x 3.5mm ceramic package
- I Wide viewing angle >140 deg
- I High reliability package
- I Standard SMD process (PnP & Reflow)
- I RoHS and REACH compliant
- I High Radiant Power up to 70mW @350mA

Targets Applications

- I Water/ Air/ Surface sterilization and disinfection
- I Food & Pharmaceutical Processing
- I Skin Therapy
- I Medical Spectroscopy
- I Florescence analyzer
- I Horticulture lighting

Product Nomenclature

The part number for Sanan SCM35BUC series deep UV package products is explained as follows:

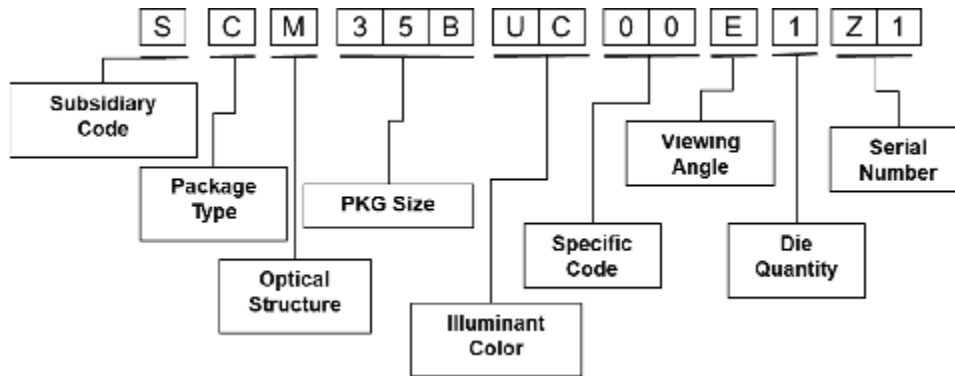

Ordering information:

Part Number: SCM35BUC00E1Z1

Specification: Refer to Bin for Forward Voltage & Radiant Power & Wavelength

C12CA035275B

Electro-Optical Characteristics @ 350mA, Ta=25°C

Parameter	Symbol	Bin	Min.	Typ.	Max.	Unit
Peak Wavelength	λ_p	270B	270	-	275	nm
		275B	275	-	280	
Output Radiant Power	P_{opt}	CA035	35	-	40	mW
		CA040	40	-	45	
		CA045	45	-	50	
		CA050	50	-	55	
		CA055	55	-	60	
		CA060	60	-	65	
Forward Voltage	V_F	C09	4.50	-	5.00	V
		C10	5.00	-	5.50	
		C11	5.50	-	6.00	
		C12	6.00	-	6.50	
		C13	6.50	-	7.00	
		C14	7.00	-	7.50	
FWHM	$\Delta\lambda$		-	9.5	-	nm
Viewing Angle	$2\theta_{1/2}$		-	150	-	°
Thermal Resistance ($T_j - T_{sp}$)	R_{th}		-	5.5	-	°C/W

Notes:

1. Radiant Flux Tolerance: $\pm 10\%$
2. Forward Voltage Tolerance: $\pm 0.1V$
3. Peak Wavelength Tolerance: $\pm 1nm$
4. Viewing Angle Tolerance: $\pm 5^\circ$
5. LEDs from the above ranks will be shipped. The rank combination ratio per shipment will be decided by Sanan

Absolute Maximum Ratings

Parameter	Symbol	Max. Ratings	Units
Forward Current	I_F	500	mA
Operating Temperature	T_{op}	0 ~ 80	°C
Storage Temperature	T_{stg}	-40 ~ 100	°C
Junction Temperature	T_j	125	°C
Soldering temperature	T_{solder}	260	°C
ESD	-	± 2	kV

Optical and Electrical Characteristics Curve

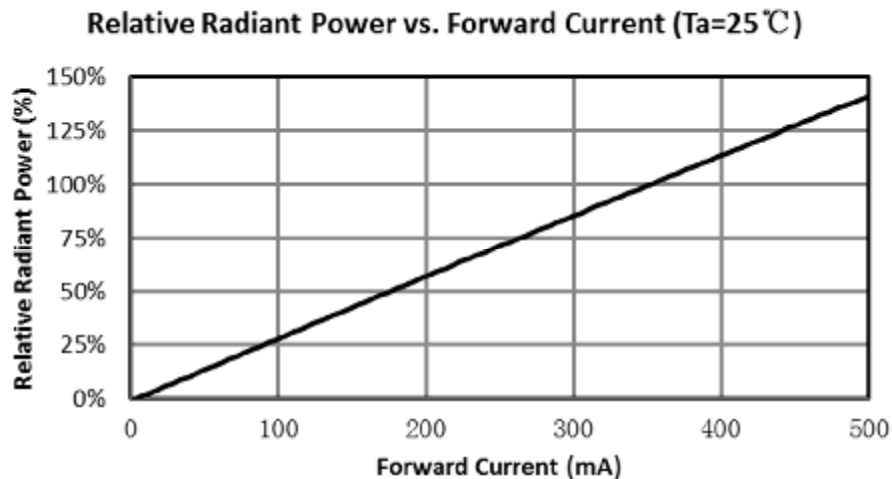

Forward Current vs. Forward Voltage (Ta=25°C)

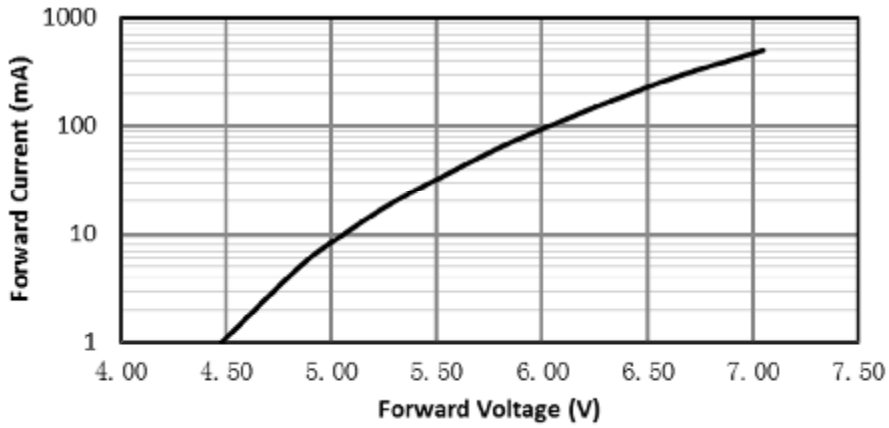

Forward Current vs. Peak Wavelength (Ta=25°C)

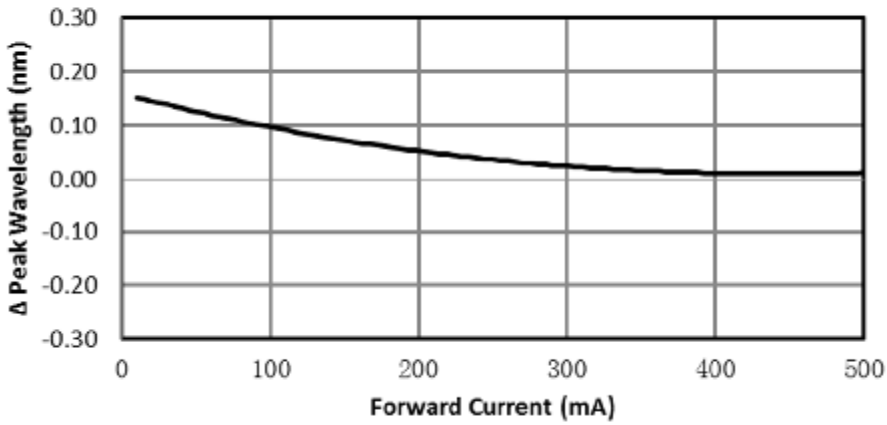

Temperature vs. Relative Radiant Power

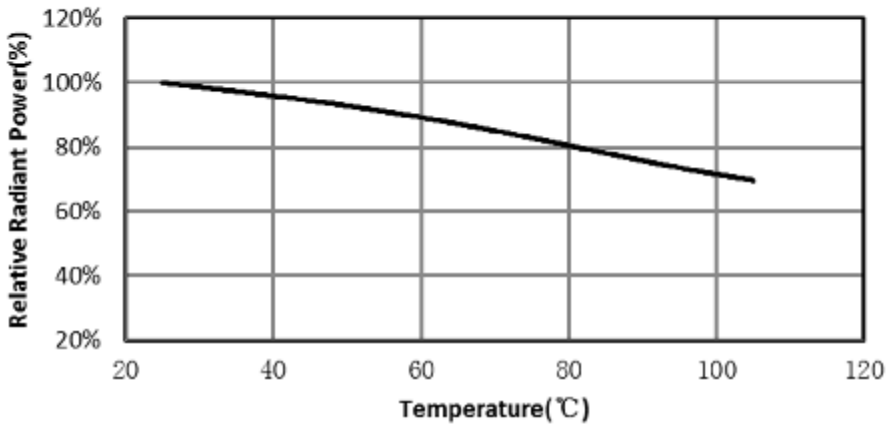

Temperature vs. Forward Voltage

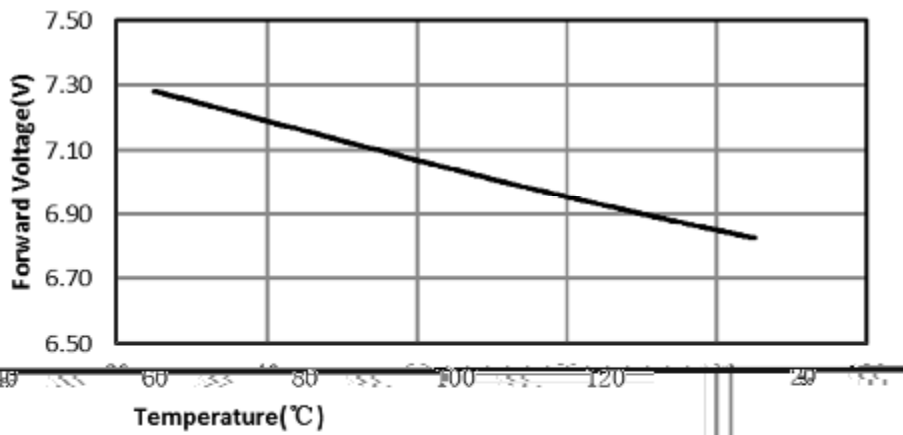

Temperature vs. Peak Wavelength

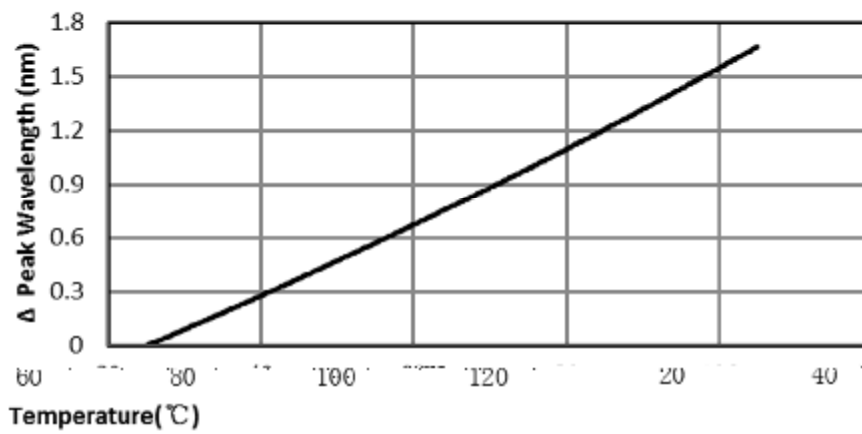

Spectrum Distribution@350mA

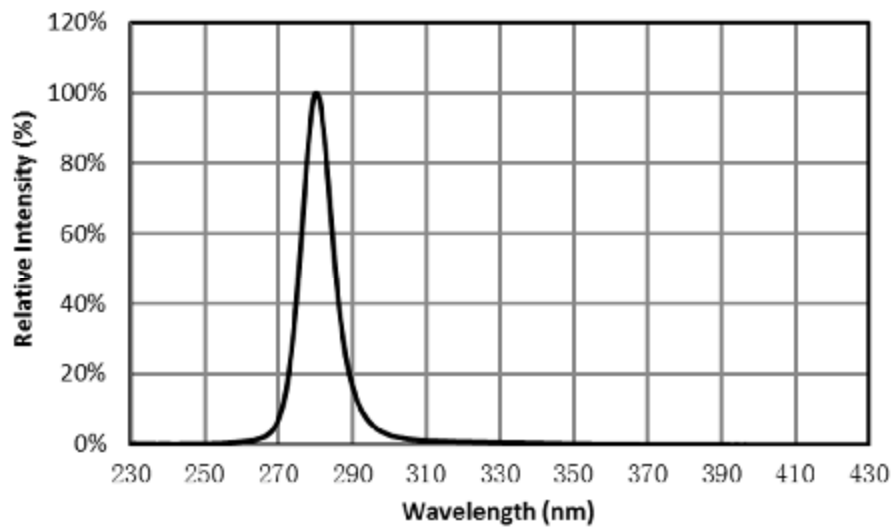

Radiation Pattern @350mA

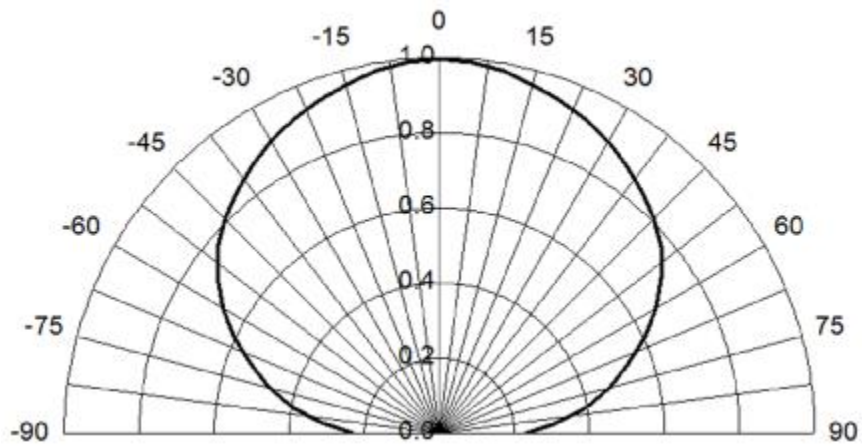

Derating Curve

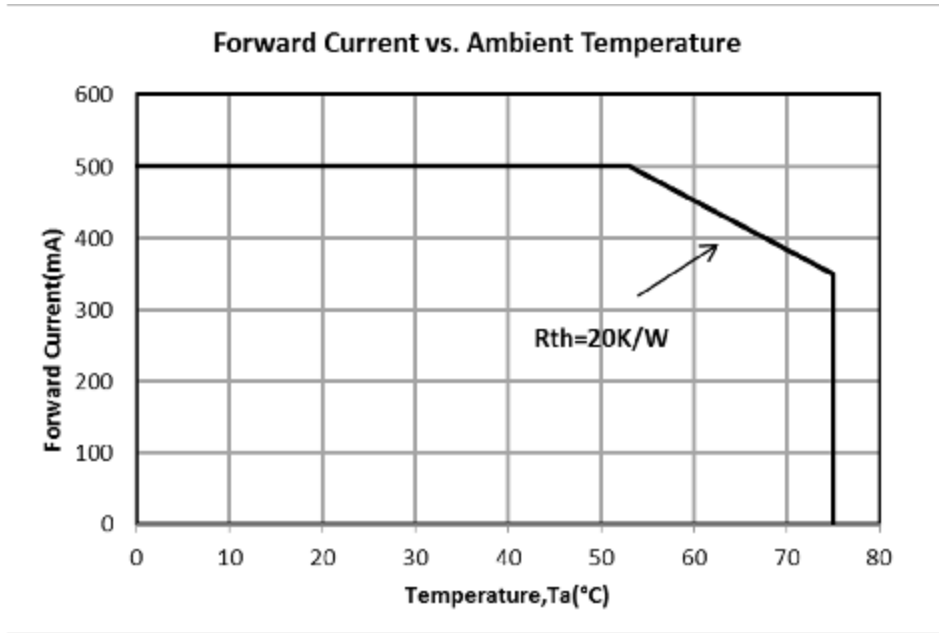

Mechanical Dimensions (Unit: mm; tolerance +/-0.1mm):

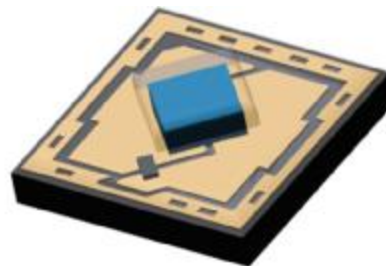
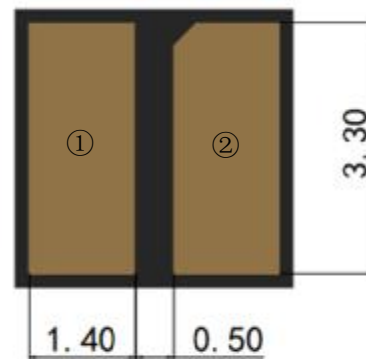
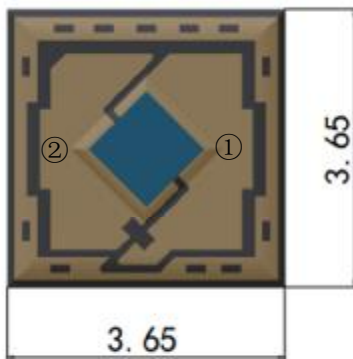

Notes: ① Anode Pad ② Cathode Pad

Recommended Solder Pad & Stencil Pattern (Unit: mm; tolerance +/-0.1mm):

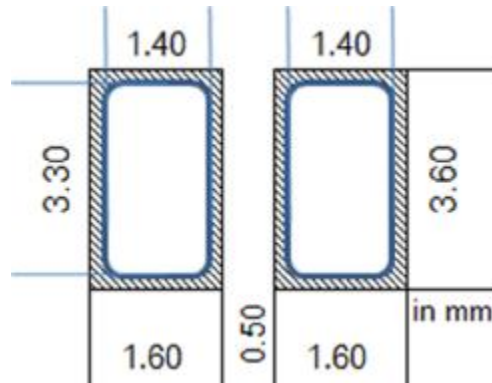

Solder Pad	3.6mm x 1.6mm
Stencil Pattern	3.3mm x 1.4mm

Recommended Reflow Profile

As a general guideline, Sanan recommends that users follow the recommended soldering profile provided by the manufacturer of the solder paste used.

Note that this general guideline may not apply to all PCB designs and configurations of reflow soldering equipment.

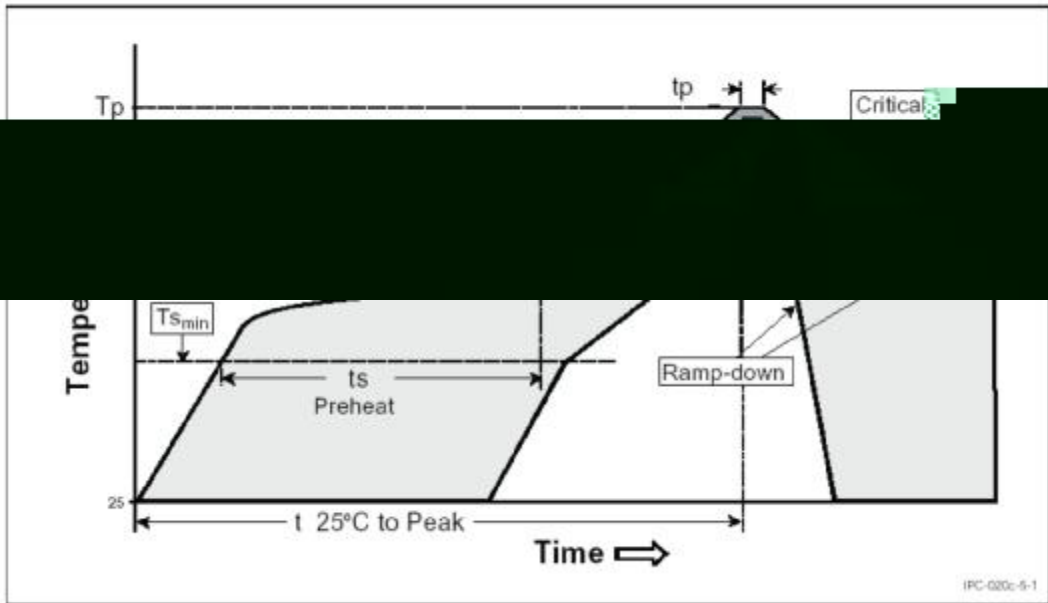

Profile Setting	Pb-Free Profile
Average Ramp-up Rate (T_{smax} to T_p)	1°C/sec
Preheat Temperature Min (T_{smin})	100-150°C
Preheat Temperature Max (T_{smax})	180-200°C
Preheat Time (t_{smin} to t_{smax})	60-120 sec
Liquidus Temperature (TL)	217°C
Time Maintained Above Time (tL)	50-80 sec
Peak / Classification Temperature (TP)	260°C
Time within 5°C of Actual Peak Temp (tp)	20-40 sec
Ramp-Down Rate	2-3°C/sec
Time 25°C Peak Temperature	4 min

Tape & Reel Packaging

(Unit: mm)

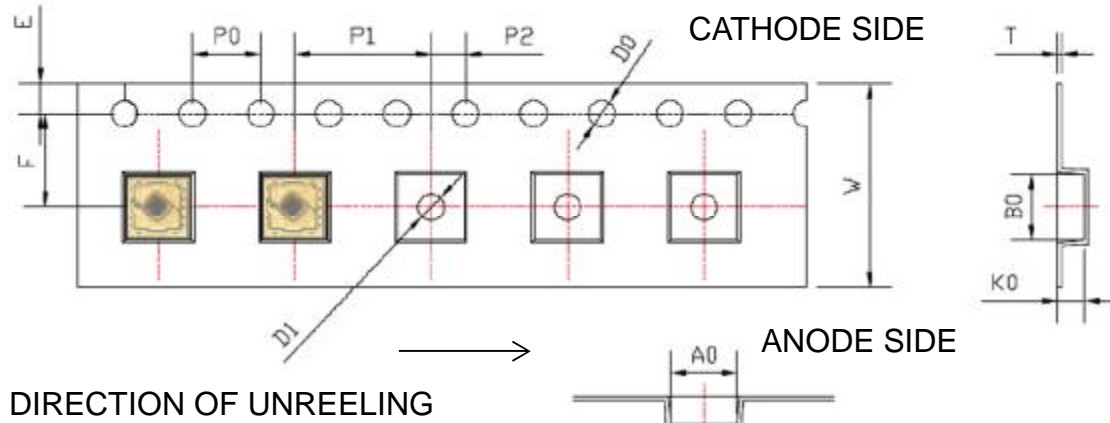

Symbol	A0	B0	K0	P0	P1	P2
Spec	4.05±0.10	4.05±0.10	1.56±0.10	4.00±0.10	8.00±0.10	2.00±0.10
Symbol	W	T	E	F	D0	D1
Spec	12.00±0.30	0.25±0.05	1.75±0.10	5.50±0.10	1.5+0.1/-0	1.5±0.10

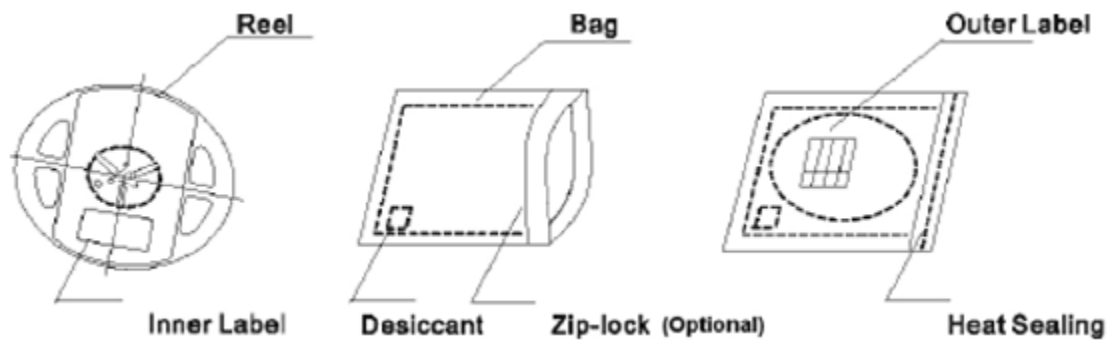
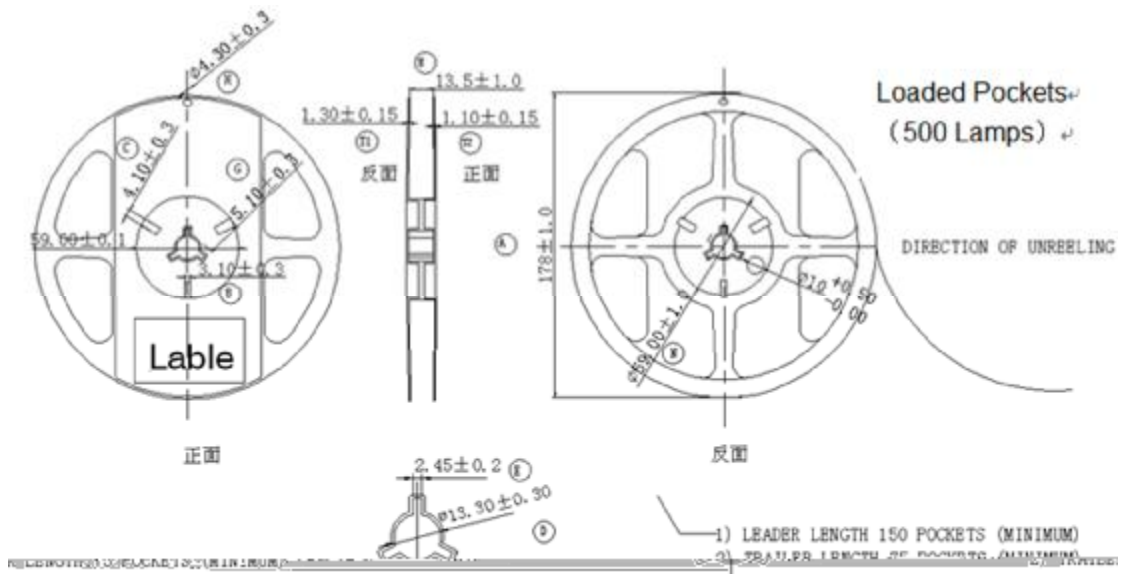

Notes: 500pcs/reel

Notes for storage and retrieval

UV Light

These devices are short wavelength Ultraviolet LED. During operation, the LED emits high intensity ultraviolet (UV) light, which is harmful to skin and eyes.

UV light is hazardous to skin and may cause cancer. Avoid exposure to UV light when LED is operational.

Precautions must be taken to avoid looking directly at the UV light without the use of UV light protective glasses. Do not look directly at the front or at the LED's lens when LED is operational.

Static Electricity (ESD)

Despite with built-in Zener protection diodes, UV LED are particularly sensitive to ESD (Electrostatic Discharge); static electricity and surge voltages seriously damage UV LEDs and can result in complete failure of the device. Precautions must be taken against ESD when handling or operating these devices.

Operating Conditions

In order to ensure the correct functioning of these LEDs, compliance to the typical electrical specifications is paramount. UV LEDs are particularly sensitive to any current value that exceed the max operating specifications, and will cause damage and possible complete failure to the device. The use of current regulated drive circuits are strongly recommended when operating these devices. These LEDs are susceptible to heat generation. Provide adequate thermal management to ensure LEDs do not exceed maximum recommended temperatures. Operating LEDs at temperatures in excess of specification will result in damage and possible complete failure of the device.

The following warning labels are attached to the product/system using ultraviolet.



Label Information

Sanan Optoelectronics

PN: **SCM35BUC00E1Z1** Spec: **C12CA035275B**
WIP ID: **CS202000805S0033**



	Min	Avg	Max	
PO:	35	37.5	40	[mw]
WP:	275	277.5	280	[nm]
VF:	6.00	6.25	6.50	[V]

I (mA) : 350

QTY: **500** 