

Deep UV LED Package (SCF35BUC00D1Z4)

Product Introduction

Sanan SCF35BUC series deep ultraviolet packaging products are specially designed for applying with high radiation power and directivity requirements. The surface mount device package is made of special ultraviolet glass with optimized life time and performance.

Features & benefits

- I With Sanan's DUV FC series dies
- I Customized emission wavelength
- I Industry standard 3.5mm x 3.5mm ceramic package
- I Wide viewing angle >120 deg
- I High reliability package
- I Standard SMD process (PnP and reflow)
- I RoHS and REACH compliant
- I Radiant Power >10mW

Targets Applications

- I Water/ Air/ Surface sterilization and disinfection
- I Food & Pharmaceutical Processing
- I Medical Spectroscopy
- I Florescence analyzer
- I Horticulture lighting

Product Nomenclature

The part number for Sanan SCF35BUC series deep UV package products is explained as follows:

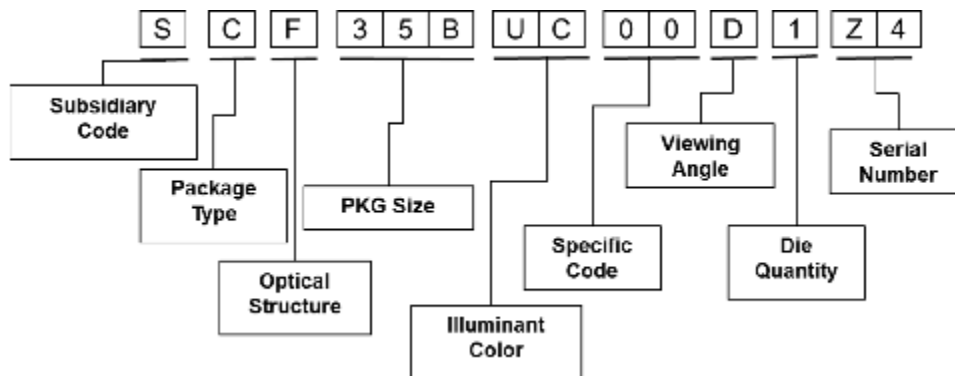

Ordering information:

Part Number: SCF35BUC00D1Z4

Specification: Refer to Bin for Wavelength & Radiant Power & Forward Voltage

275BCA010C09

Electro-Optical Characteristics @ 100mA

Parameter	Symbol	Bin	Min.	Typ.	Max.	Unit
Peak Wavelength	λ_P	270B	270	-	275	nm
		275B	275	-	280	
Output Radiant Power	P_{opt}	CA010	10.0	-	15.0	mW
		CA015	15.0	-	20.0	
Forward Voltage	V_F	C09	4.5	-	5.0	V
		C10	5.0	-	5.5	
		C11	5.5	-	6.0	
		C12	6.0	-	6.5	
		C13	6.5	-	7.0	
		C14	7.0	-	7.5	
FWHM	$\Delta\lambda$		-	9.5	-	nm
Viewing Angle	$2\theta_{1/2}$		-	130	-	°
Thermal Resistance ($T_j - T_{sp}$)	R_{th}		-	10	-	°C/W

Notes:

1. Radiant Flux Tolerance: $\pm 10\%$
2. Forward Voltage Tolerance: $\pm 0.1V$
3. Peak Wavelength Tolerance: $\pm 1nm$
4. Viewing Angle Tolerance: $\pm 5^\circ$
5. LEDs from the above ranks will be shipped. The rank combination ratio per shipment will be decided by Sanan

Absolute Maximum Ratings

Parameter	Symbol	Max. Ratings	Units
Forward Current	I_F	200	mA
Reverse Voltage	V_R	-5	V
Operating Temperature	T_{op}	-40 ~ 85	°C
Storage Temperature	T_{stg}	-40 ~ 105	°C
Junction Temperature	T_j	115	°C
Soldering temperature	T_{solder}	260	°C

Optical and Electrical Characteristics Curve

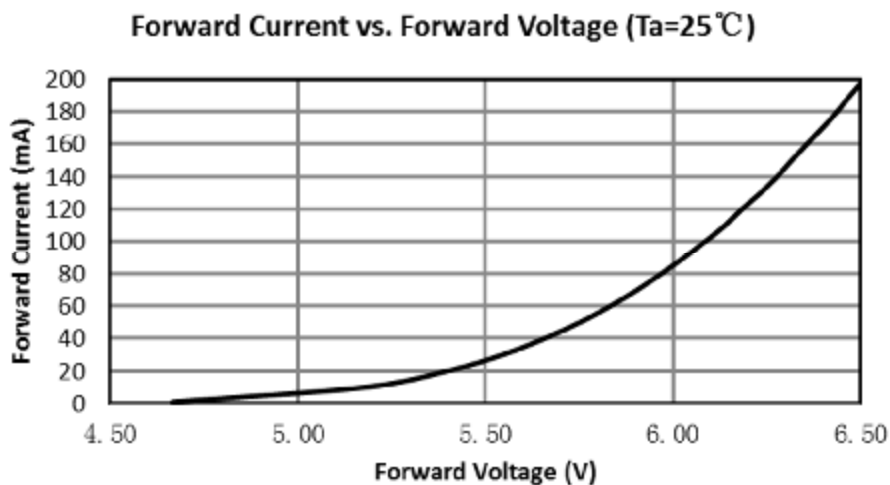
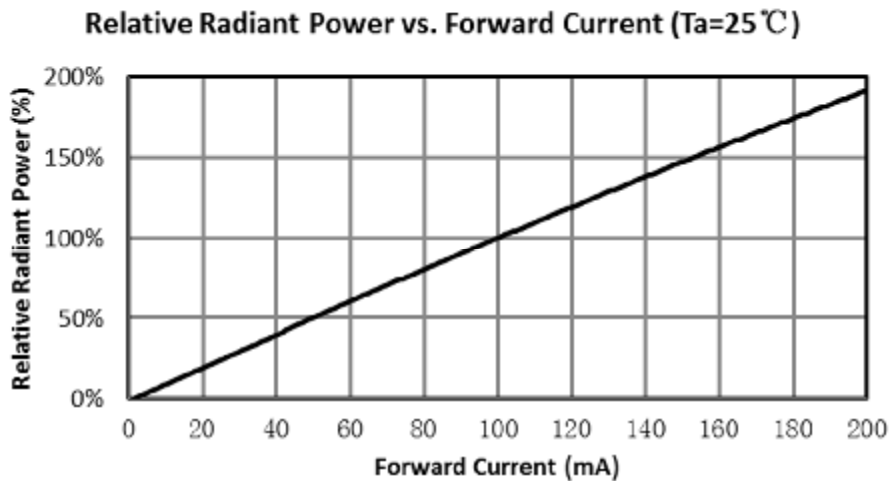

Forward Current vs. Peak Wavelength (Ta=25 °C)

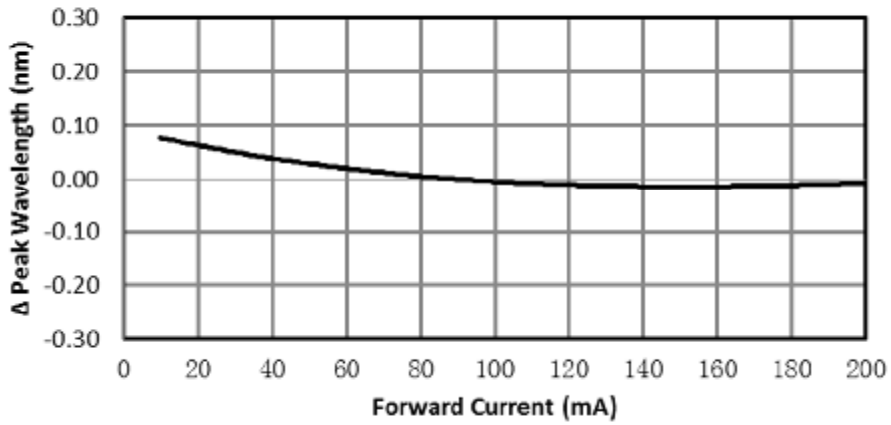

Temperature vs. Relative Radiant Power

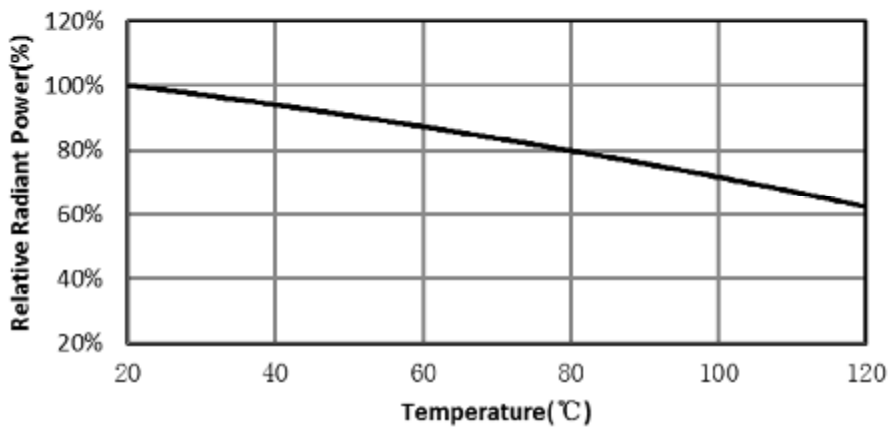

Temperature vs. Forward Voltage

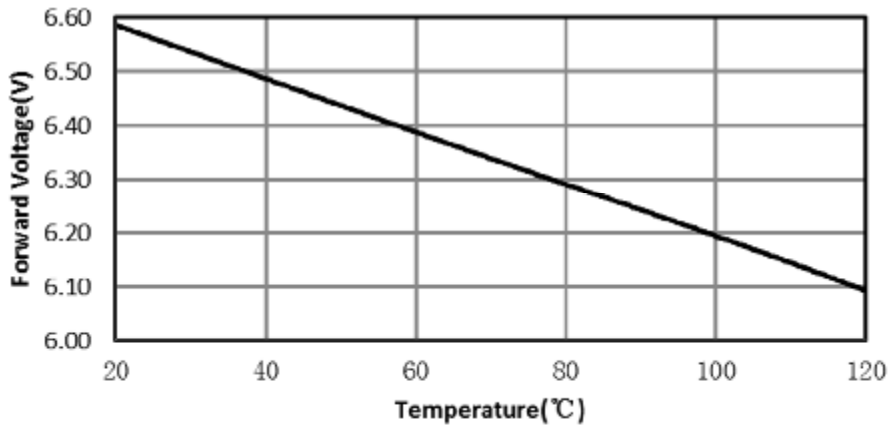

Temperature vs. Forward Voltage

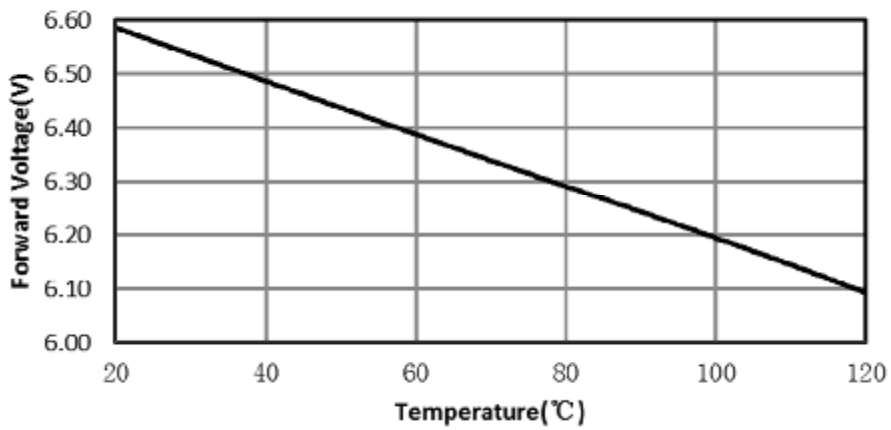

Temperature vs. Peak Wavelength

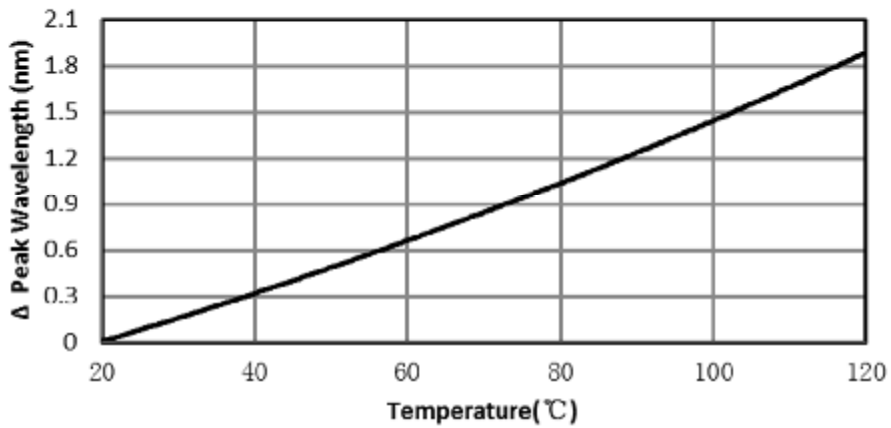

Spectrum Distribution@100mA

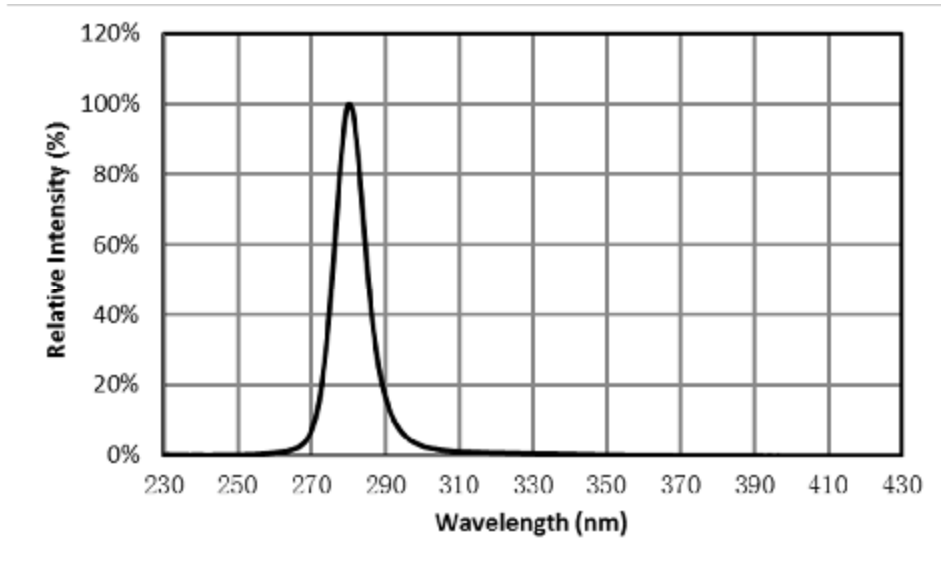

Radiation Pattern @100mA

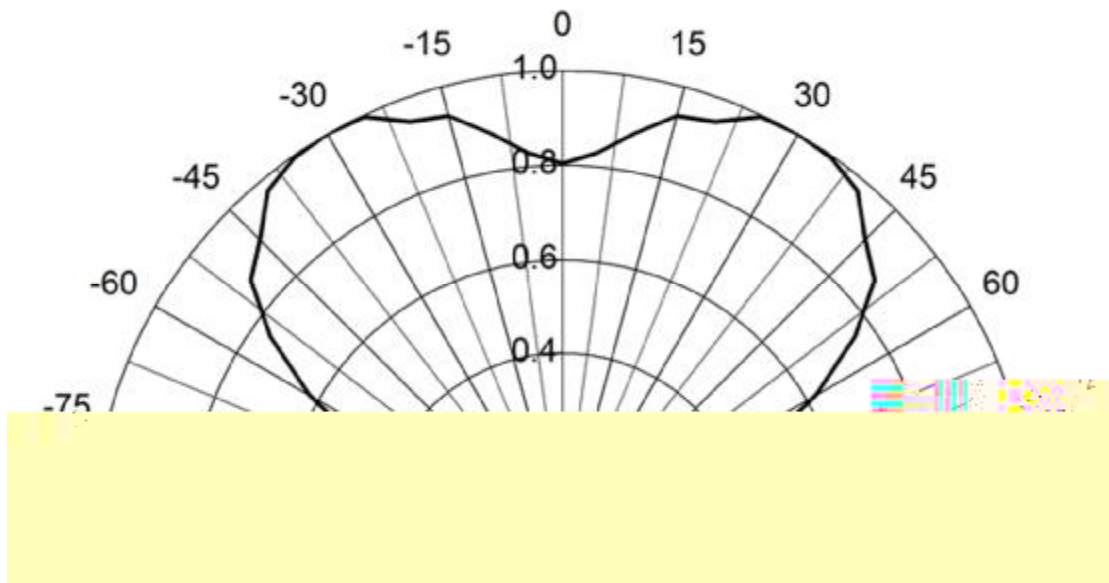

Mechanical Dimensions (Unit: mm; tolerance +/-0.1mm):

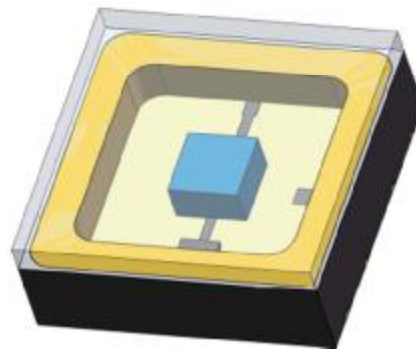
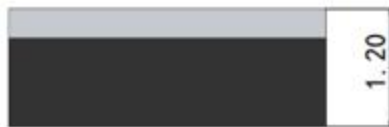
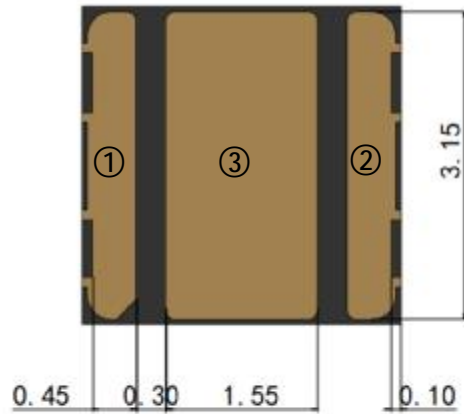
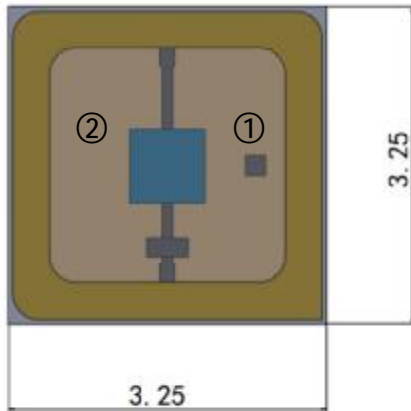

Notes : ① Cathode Pad ② Anode Pad ③ Heat Sink

Recommended Solder Pad & Stencil Pattern (Unit: mm; tolerance +/-0.1mm):

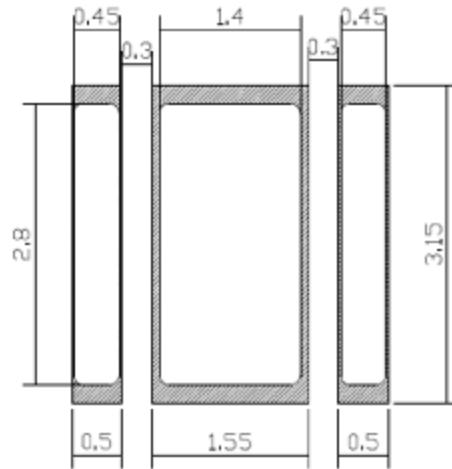

Solder Pad	3.15mm x 0.50mm
	3.15mm x 1.55mm
Stencil Pattern	2.80mm x 0.45mm
	2.80mm x 1.40 mm

Recommended Reflow Profile

As a general guideline, Sanan recommends that users follow the recommended soldering profile provided by the manufacturer of the solder paste used.

Note that this general guideline may not apply to all PCB designs and configurations of reflow soldering equipment.

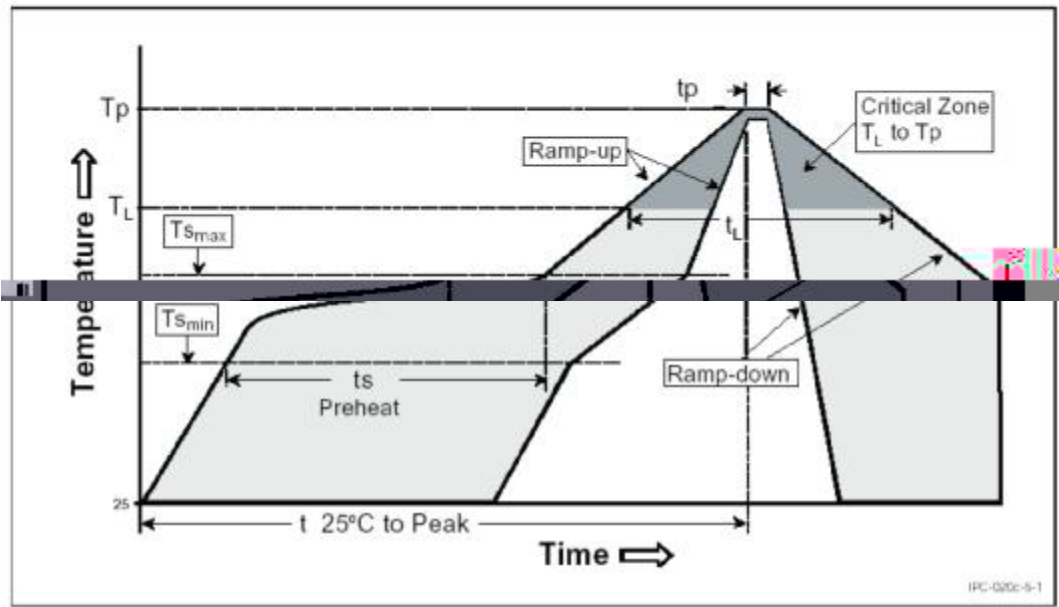

Profile Setting	Pb-Free Profile
Average Ramp-up Rate (T _{smax} to T _p)	1°C/sec
Preheat Temperature Min (T _{smin})	100-150°C
Preheat Temperature Max (T _{smax})	180-200°C
Preheat Time (t _{smin} to t _{smax})	60-120 sec
Liquidus Temperature (T _L)	217°C
Time Maintained Above Time (t _L)	50-80 sec
Peak / Classification Temperature (T _P)	260°C
Time within 5°C of Actual Peak Temp (t _P)	20-40 sec
Ramp-Down Rate	2-3°C/sec
Time 25°C Peak Temperature	4 min

Reliability Test

Item	Conditions	Failure Criteria
Room Temperature Operating Life	25 °C, 100mA, 1000Hrs	Forward Voltage $V_F < 110\%$ Radiant Power, $P_{opt} > 70\%$
High Temperature Storage	105°C, 1000Hrs	
Low Temperature Storage	-40°C, 1000Hrs	
Temperature Cycles (100cycles)	-45°C (30 min) ~ +25°C (5 min) +125°C (30 min) ~ +25°C (5 min)	
ESD (Human Body Mode)	R = 1.5 KΩ, C = 100 pF; Test Voltage = 2KV, 3 times negative/positive	
Moisture Sensitive Level(MSL)	3 time reflow, peak temperature +260 °C, 10s Pre-conditioning: +30 °C, 60% RH for 192h	
Vibration Test	20Hz-2000Hz-20Hz, 200m/s ² , 4cycles, 4 min, each X, Y, Z	

Tape & Reel Packaging

(Unit: mm)

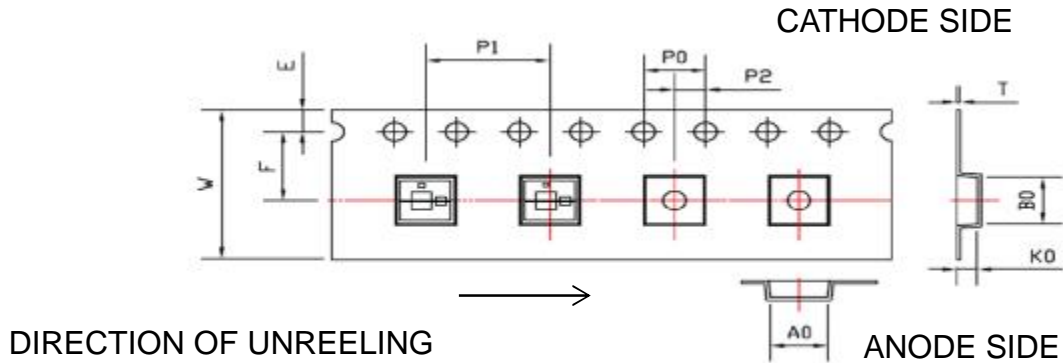

Symbol	A0	B0	K0	P0	P1	P2
Spec	3.70 ± 0.05	3.73 ± 0.05	1.35 ± 0.05	4.00 ± 0.10	8.00 ± 0.10	2.00 ± 0.05
Symbol	W	T	E	F	D0	D1
Spec	12.00 ± 0.20	0.25 ± 0.05	1.75 ± 0.10	5.50 ± 0.10	$1.5 + 0.1 / -0$	1.5 ± 0.05

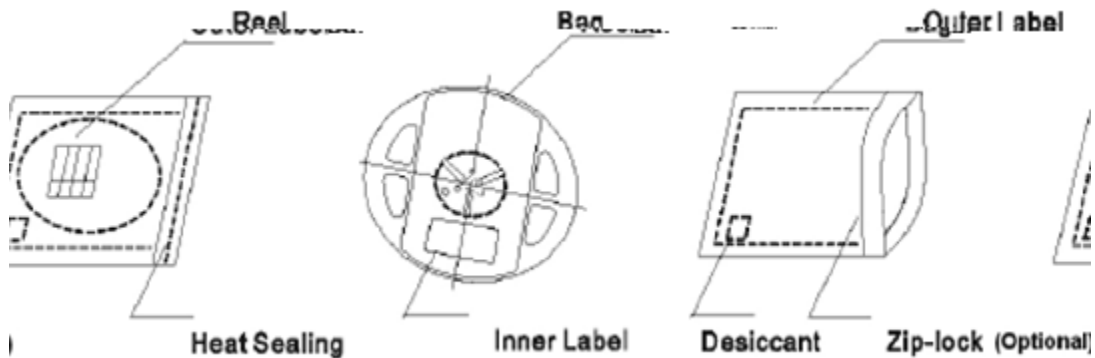
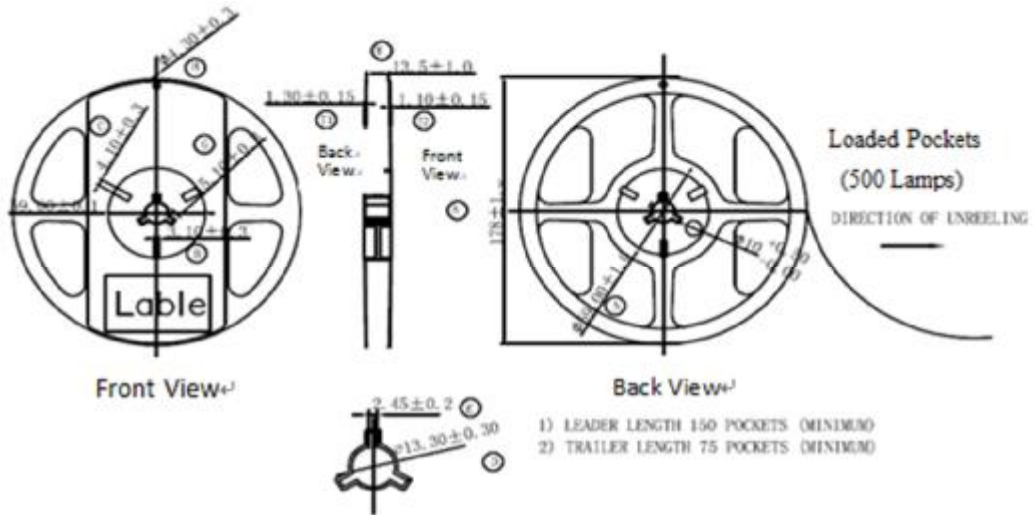

Notes: 500pcs/reel

Notes for storage and retrieval

UV Light

These devices are short wavelength Ultraviolet LED. During operation, the LED emits high intensity ultraviolet (UV) light, which is harmful to skin and eyes.

UV light is hazardous to skin and may cause cancer. Avoid exposure to UV light when LED is operational.

Precautions must be taken to avoid looking directly at the UV light without the use of UV light protective glasses. Do not look directly at the front or at the LED's lens when LED is operational.

Static Electricity (ESD)

Despite with built-in Zener protection diodes, UV LED are particularly sensitive to ESD (Electrostatic Discharge); static electricity and surge voltages seriously damage UV LEDs and can result in complete failure of the device. Precautions must be taken against ESD when handling or operating these devices.

Operating Conditions

In order to ensure the correct functioning of these LEDs, compliance to the typical electrical specifications is paramount. UV LEDs are particularly sensitive to any current value that exceed the max operating specifications, and will cause damage and possible complete failure to the device. The use of current regulated drive circuits are strongly recommended when operating these devices. These LEDs are susceptible to heat generation. Provide adequate thermal management to ensure LEDs do not exceed maximum recommended temperatures. Operating LEDs at temperatures in excess of specification will result in damage and possible complete failure of the device.



The following warning labels are attached to the product/system using ultraviolet.



Label Information

Sanan Optoelectronics

PN: SCF35BUC00D1Z4 Spec: 275BCA010C09
 Lot Cd: UN1911040001 WP: US2001130001

	Min	Avg	Max	
PO:	10	12.5	15	[mw]
WP:	275	277.5	280	[nm]
VF:	4.5	4.75	5	[V]

I (mA) : 100

QTY: 500 